



stratasys®



# Antero 840CN03

## FDM Thermoplastic Filament

The information presented are typical values intended for reference and comparison purposes only. They should not be used for design specifications or quality control purposes.





## Overview

Antero™ 840CN03 is a PEKK-based FDM thermoplastic combining the excellent physical and mechanical qualities of PEKK with electrostatic dissipative (ESD) properties. The material is filled 3% by weight with carbon nanotubes.

As a high-performance polymer, Antero 840CN03 exhibits exceptional chemical and wear resistance, ultra-low outgassing properties and consistent ESD performance. ESD values range from  $10^4 - 10^9$  ohms per square inch. This makes the material particularly suitable for space and industrial applications where these qualities are critical.

## Contents:

Overview .....	2
Ordering Information .....	3
Physical Properties.....	4
Mechanical Properties.....	5
Performance at Temperature .....	8
UV Aging .....	8
ESD Properties .....	9
Chemical Resistance .....	11
Flame, Smoke, and Toxicity.....	14
Outgassing .....	15
Appendix.....	16



## Ordering Information

**Table 1: Printer and Support Material Compatibility**

Printer	Model Tip	Layer Height	Support Material	Support Tip
Fortus 450mc™	T20F	0.254 mm (0.010 in.)	SUP8000B™ (breakaway)	T16
F900®	T20D	0.254 mm (0.010 in.)	SUP8000B (breakaway)	T16
F900®	T20F	0.254 mm (0.010 in.)	SUP8000B (breakaway)	T16

### Build Sheet

#### High Temperature

- 0.51 x 406 x 470 mm (0.02 x 16 x 18.5 in.)
- 0.51 x 660 x 965 mm (0.02 x 26 x 38 in.)

### System Requirements

#### Fortus 450mc

- Hardened machine upgrade
- Hardened Fortus 450mc head
- Antero 840CN03 material license (included if new system)

#### F900

- Hardened F900 head
- Antero 840CN03 material license

**Table 2: Antero 840CN03 Ordering Information**

Part Number	Description
<b>Filament Canisters</b>	
355-02510	Antero 840CN03, 92.3 cu in. – Plus
355-03260	SUP8000B, 92.3 cu in. – Plus
<b>Printer Consumables</b>	
511-10730-S	T20D tip
511-10740-S	T20F tip
511-10401	T16 tip
325-00275-S	High Temperature build sheet, 0.02 x 16 x 18.5 in. (0.51 x 406 x 470 mm)
325-00475-S	High Temperature build sheet, 0.02 x 26 x 38 in. (0.51 x 660 x 965 mm)
<b>Print Heads</b>	
821726-XXXX	Hardened Fortus 450mc head (blue handle)
325-63500	Hardened F900 head (folded sheet metal handle)



## Physical Properties

Values are measured as printed. XY, XZ, and ZX orientations were tested. For full details refer to the [Stratasys Materials Test Procedure](#). DSC and TMA curves can be found in the Appendix.

**Table 3: Antero 840CN03 Physical Properties**

Property	Test Method	XY	XZ/ZX
HDT @ 66 psi	ASTM D648 Method B	157.7 °C (315.8 °F)	158.4 °C (317.1 °F)
HDT @ 264 psi	ASTM D648 Method B	158.0 °C (316.3 °F)	157.0 °C (314.6 °F)
Molded HDT @ 66 psi	ASTM D648 Method B	149.5 °C (301.1 °F)	
Molded HDT @ 264 psi	ASTM D648 Method B	150.8 °C (303.4 °F)	
Tg	ASTM D7426 Inflection Point	157.6 °C (315.7 °F)	
Melt Point	ASTM D7426 Peak Heat	300.3 °C (572.5 °F)	
Mean CTE	ASTM E831 (40 °C to 140 °C)	47.4 μm/[m*°C] 26.33 μin/[in*°F]	51.24 μm/[m*°C] 28.47 μm/[m*°F]
Volume Resistivity <sup>1</sup>	ASTM D257	10 <sup>4</sup> -10 <sup>9</sup> * Ω*cm	
Thermal Conductivity	ASTM E1952 @0 °C	0.2369 W/m*K 0.1369 BTU/(hr*ft°F)	
Thermal Conductivity	ASTM E1952 @30 °C	0.2447 W/m*K 0.1414 BTU/(hr*ft°F)	
Thermal Conductivity	ASTM E1952 @60 °C	0.2530 W/m*K 0.1462 BTU/(hr*ft°F)	
Thermal Conductivity	ASTM E1952 @90 °C	0.2567 W/m*K 0.1483 BTU/(hr*ft°F)	
Thermal Diffusivity	ASTM E1952 @0 °C	0.162 mm <sup>2</sup> /s 2.51*10 <sup>-4</sup> in <sup>2</sup> /s	
Thermal Diffusivity	ASTM E1952 @30 °C	0.150 mm <sup>2</sup> /s 2.33*10 <sup>-4</sup> in <sup>2</sup> /s	
Thermal Diffusivity	ASTM E1952 @60 °C	0.142 mm <sup>2</sup> /s 2.20*10 <sup>-4</sup> in <sup>2</sup> /s	
Thermal Diffusivity	ASTM E1952 @90 °C	0.134 mm <sup>2</sup> /s 2.08*10 <sup>-4</sup> in <sup>2</sup> /s	
Specific Gravity	ASTM D792 @23 °C	1.27	

<sup>1</sup>See ESD section.



## Mechanical Properties

Samples were printed with 0.254 mm (0.010 in.) layer heights on the Fortus 450mc and F900 with a T20F tip. For the full test procedure please see [Stratasys Materials Test Procedure](#).

### Print Orientation

Parts created using FDM are anisotropic as a result of the printing process. Below is a reference of the different orientations used to characterize the material.

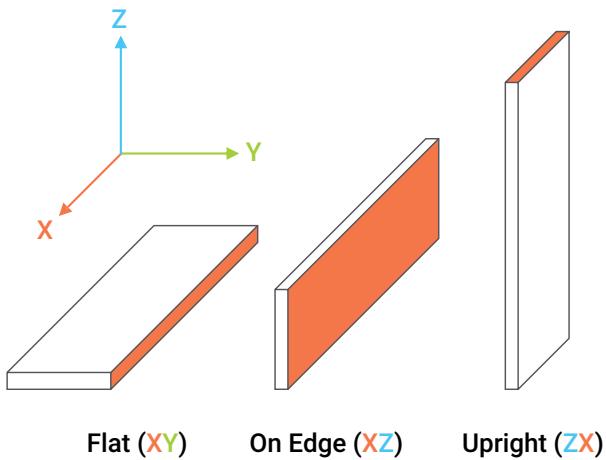

### Tensile Curves

Due to the anisotropic nature of FDM, tensile curves look different depending on orientation. Below is a guide of the two types of curves seen when printing tensile samples and what reported values mean.

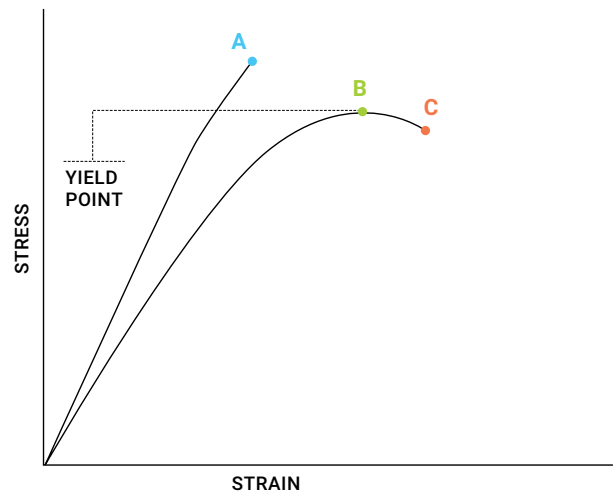

A = Tensile at break, elongation at break (no yield point)

B = Tensile at yield, elongation at yield

C = Tensile at break, elongation at break

**Table 4: Antero 840CN03 Mechanical Properties - 450mc - T20F Tip**

0.254 mm (0.010 in.) Layer Height		XZ Orientation <sup>1</sup>	ZX Orientation <sup>1</sup>
<b>Tensile Properties: ASTM D638</b>			
<b>Yield Strength</b>	MPa	94.9 (1.0)	56.0 (5.0)
	psi	13800 (140)	8110 (720)
<b>Elongation @ Yield</b>	%	4.9	2.0
<b>Strength @ Break</b>	MPa	No Break	55.8 (4.9)
	psi	No Break	8090 (710)
<b>Elongation @ Break</b>	%	No Break	2.0
<b>Modulus (Elastic)</b>	GPa	2.96 (0.03)	3.02 (0.046)
	ksi	430 (4.9)	438 (6.7)
<b>Flexural Properties: ASTM D790, Procedure A</b>			
<b>Strength @ Break</b>	MPa	No Break	89.0 (9.4)
	psi	No Break	12900 (1400)
<b>Strength @ 5% Strain</b>	MPa	146 (1.7)	-
	psi	21100 (240)	-
<b>Strain @ Break</b>	%	No Break	3.2
<b>Modulus</b>	GPa	3.44 (0.04)	2.89 (0.08)
	ksi	499 (6.0)	419 (11)
<b>Compression Properties: ASTM D695</b>			
<b>Yield Strength</b>	MPa	106 (1.7)	109 (3.0)
	psi	15400 (240)	15700 (430)
<b>Modulus</b>	GPa	2.55 (0.04)	2.52 (0.05)
	ksi	369 (5.4)	365 (6.8)
<b>Impact Properties: ASTM D256, ASTM D4812</b>			
<b>Notched</b>	J/m	45.0 (6.0)	29.7 (5.9)
	ft*lb/in.	0.842 (0.11)	0.556 (0.11)
<b>Unnotched</b>	J/m	4060 (1600)	124 (30)
	ft*lb/in.	76.0 (29)	2.32 (0.56)

<sup>1</sup>Values in parentheses are standard deviations.

**Table 5: Antero 840CN03 Mechanical Properties - F900 - T20F Tip**

0.254 mm (0.010 in.) Layer Height		XZ Orientation <sup>1</sup>	ZX Orientation <sup>1</sup>
<b>Tensile Properties: ASTM D638</b>			
<b>Yield Strength</b>	MPa	93.9 (2.15)	53.1 (4.1)
	psi	13600 (310)	7690 (600)
<b>Elongation @ Yield</b>	%	4.8	1.9
<b>Strength @ Break</b>	MPa	54.1 (11)	52.6 (4.0)
	psi	7850 (1500)	7630 (580)
<b>Elongation @ Break</b>	%	12	1.9
<b>Modulus (Elastic)</b>	GPa	2.94 (0.05)	2.88 (0.07)
	ksi	426 (7.5)	418 (11)
<b>Flexural Properties: ASTM D790, Procedure A</b>			
<b>Strength @ Break</b>	MPa	No Break	85.3 (14)
	psi	No Break	12400 (2100)
<b>Strength @ 5% Strain</b>	MPa	144 (4.6)	-
	psi	20800 (670)	-
<b>Strain @ Break</b>	%	No Break	3.1
<b>Modulus</b>	GPa	3.43 (0.09)	2.80 (0.06)
	ksi	498 (13)	405 (9.2)
<b>Compression Properties: ASTM D695</b>			
<b>Yield Strength</b>	MPa	106 (3.3)	106 (3.1)
	psi	15400 (480)	15400 (440)
<b>Modulus</b>	GPa	2.60 (0.04)	2.56 (0.03)
	ksi	377 (6.0)	371 (4.5)
<b>Impact Properties: ASTM D256, ASTM D4812</b>			
<b>Notched</b>	J/m	45.8 (5.9)	30.7 (4.4)
	ft*lb/in.	0.858 (0.11)	0.575 (0.08)
<b>Unnotched</b>	J/m	1930 (950)	143.2 (32)
	ft*lb/in.	36.2 (18)	2.68 (0.61)

<sup>1</sup> Values in parentheses are standard deviations.



## Performance at Temperature

Antero 840CN03 was tested at various temperatures. Ten ASTM D638 upright (ZX) T20F dogbone coupons were tested in tensile. The percent change from the reported room temperature results are listed below. For more information, see the [FDM Strength Performance Across Temperatures white paper](#).

**Table 6. Performance of Antero 840CN03 at Temperature - T20F Tip**

Material	Temperature		Strength at Break	Elongation at Break	Modulus
	(°F)	(°C)			
Antero 840CN03	-65	-54	98%	89%	120%
	-40	-40	99%	89%	119%
	120	49	94%	100%	105%
	180	82	98%	111%	103%
	220	104	96%	126%	102%
	270	132	76%	132%	101%

## UV Aging

Antero 840CN03 was tested before and after UV exposure. Ten ASTM D638 upright (ZX) dogbones were tested in tensile after UV exposure and an additional 10 ASTM D638 ZX dogbones were the control (no UV Exposure). The UV exposed samples were cycled in the QUV chamber per ASTM G154 (Standard Practice for Operating Fluorescent Ultraviolet (UV) Lamp Apparatus for exposure of Non-metallic Materials) for 1000 hours, alternating for 8 hours at 60 °C (140 °F) and 4 hours at 50 °C (122 °F) with humidity and condensation. The increase in stress at break is from the control samples.

For more information see the Impact of [UV Exposure on FDM Materials white paper](#).

**Table 7: UV Aging of Antero 840CN03 - F900 - T20F Tip**

Material	Conditioning	Yield Strength		Stress at Break		Elongation at Break	Increase in Stress at Break	Modulus	
		(psi)	(MPa)	(psi)	(MPa)			(ksi)	(GPa)
Antero 840CN03	No UV Exposure	8270	57	8400	57.9	2.4	-	396	2.73
	UV Exposure	8050	55.5	8040	55.4	2.2	-4.30	401	2.76



## ESD Properties

Antero 840CN03 was tested per ANSI ESD S20.20, S11.11, STM11.12 to determine the effect that build parameters and part geometries had on ESD properties. Different geometries printed in different orientations all fall into the ESD safe range ( $10^4$  to  $10^9$  ohms). For full details, see the [Antero 840CN03 ESD White Paper](#).

**Figure 1a: 4 x 4 x 0.1 in. Plaque Resistance on the Fortus 450mc in Various Build Orientations**

### Fortus 450mc

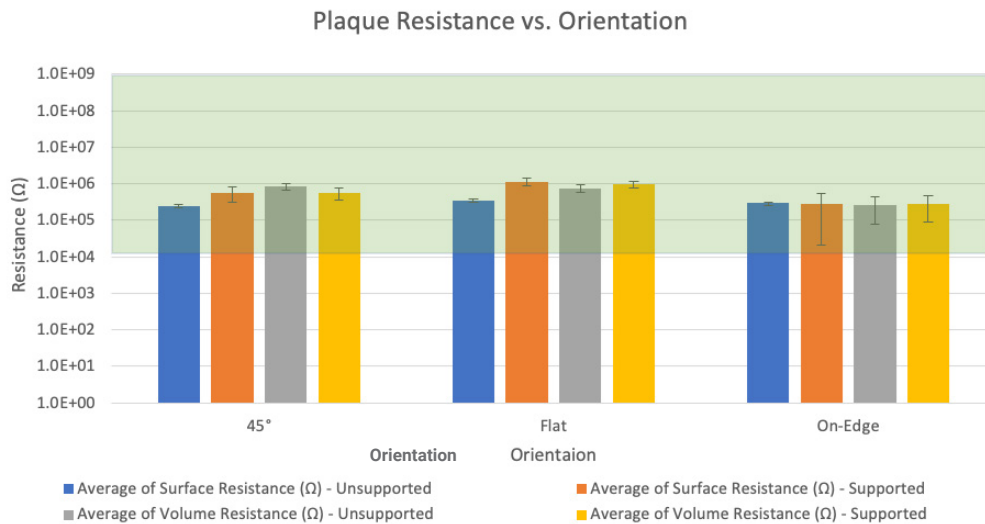

**Figure 1b: 4 x 4 x 0.1 in. Plaque Resistance on the F900 in Various Build Orientations**

### F900

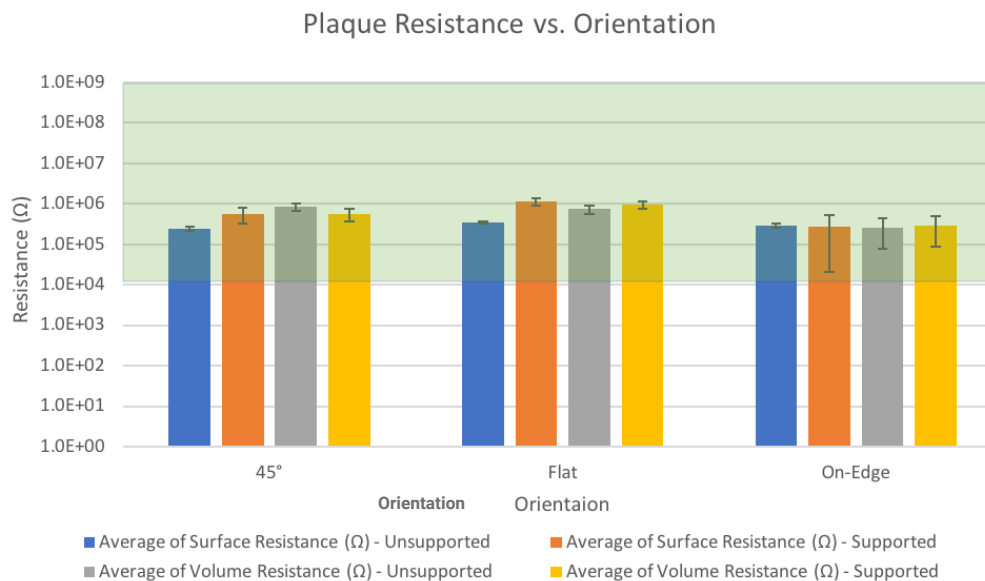



**Figure 2a: Volume Resistance of Hollow Cylinders With Respect to Wall Thickness, Build Orientation, and Location on the Cylinder on the Fortus 450mc**

Fortus 450mc

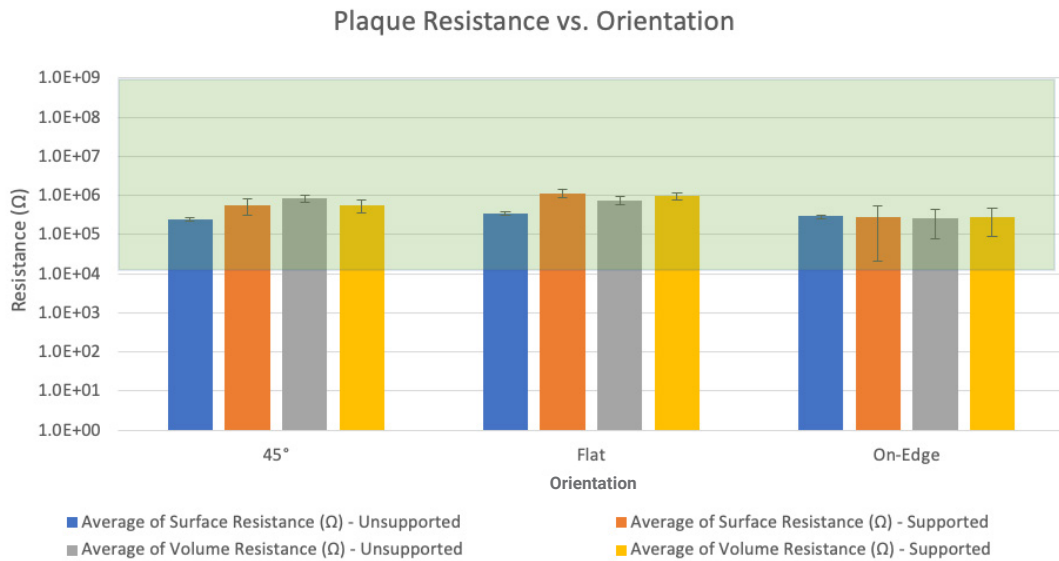

**Figure 2b: Volume Resistance of Hollow Cylinders With Respect to Wall Thickness, Build Orientation, and Location on the Cylinder on the F900**

F900

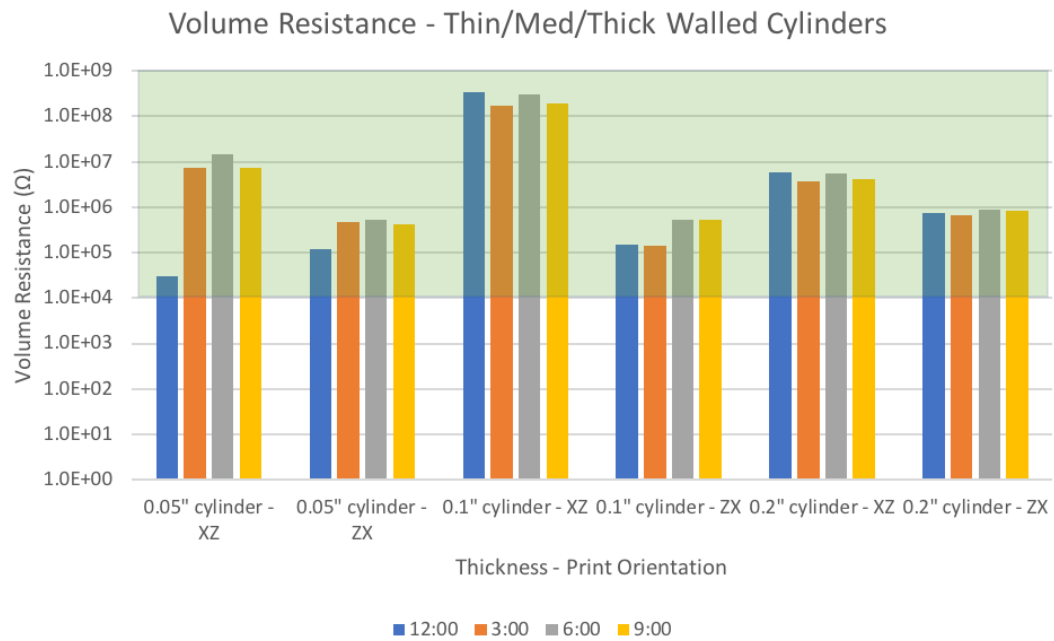



## Chemical Resistance

Antero 840CN03 was tested for resistance to chemical exposure per ASTM D543. Chemicals tested and percent change from control is listed below. For further details read the [Antero 840CN03 Chemical Resistance White Paper](#).

**Table 8: Antero 840CN03 Thermoplastic Filament Chemical Resistance Results**

Change in Mechanical Properties, Antero 840CN03 - 168 Hour Chemical Exposure (ASTM D543)			
	Reagent	XZ Orientation	ZX Orientation
Tensile Strength	Dichloromethane	-87.6%	-74.8%
	Ethyl Acetate	-2.9%	-2.3%
	Jet A	-2.1%	7.3%
	MEK	-0.7%	-2.1%
	Skydrol	-2.1%	6.3%
	Toluene	-5.0%	1.4%
	30% Nitric Acid	-5.7%	5.7%
	30% Sulfuric Acid	-9.3%	-10.1%
	60% Sodium Hydroxide	-1.4%	1.9%
	Concentrated Ammonia	-1.4%	11.0%
% Elongation @ break	Dichloromethane	714.8%	1,598.4%
	Ethyl Acetate	4.2%	16.2%
	Jet A	-0.4%	7.0%
	MEK	-4.4%	11.9%
	Skydrol	32.3%	9.7%
	Toluene	17.2%	32.4%
	30% Nitric Acid	61.4%	52.4%
	30% Sulfuric Acid	47.2%	-5.4%
	60% Sodium Hydroxide	5.2%	-1.6%
	Concentrated Ammonia	11.1%	10.8%
Tensile Modulus	Dichloromethane	-90.7%	-85.3%
	Ethyl Acetate	1.8%	6.4%
	Jet A	1.4%	5.3%
	MEK	3.1%	4.3%
	Skydrol	0.6%	6.7%
	Toluene	-0.4%	6.2%
	30% Nitric Acid	-0.8%	-6.2%
	30% Sulfuric Acid	-7.6%	-5.0%
	60% Sodium Hydroxide	0.2%	3.3%
	Concentrated Ammonia	-0.4%	5.0%



## Flame, Smoke, and Toxicity (Fortus 450mc)

Antero 840CN03 was printed with a T20F tip on the Stratasys Fortus 450mc and tested per 14 CFR 25.853, BSS 7238 and 7239, and AITM 2.0007B, and 3.0005. The testing establishes that this material, samples 1.016 mm (0.040 in.) thick unless otherwise noted, **meets requirements** for:

- 60s and 12s Vertical Burn
- 15s Horizontal Burn
- Toxic Gas Emission
- Smoke Density
- Heat Release Rate of Cabin Materials

**Table 9: Antero 840CN03 Flame, Smoke and Toxicity Test Results - Fortus 450mc**

	Avg Time to Extinguish (seconds)	Avg Burned Length (inches)	Avg Burned Length (centimeters)	Drip Time to Extinguish (seconds)
12 Second Vertical Ignition per 14 CFR 25.853(a), Appendix F, Part I, Paragraph (a)(1)(ii)				
Antero 840CN03, Vertical - ZX	2.9	0.2	0.5	0 (No drips)
Antero 840CN03, Flat - XY	6.7	0.2	0.5	0 (No drips)
60 Second Vertical Ignition per 14 CFR 25.853(a), Appendix F, Part I, Paragraph (a)(1)(ii)				
Antero 840CN03, Vertical - ZX	<1	0.4	1.02	0 (No drips)
Antero 840CN03, Flat - XY	<1	0.5	1.27	0 (No drips)
	(in/min)	Avg Burn Rate		(cm/min)
15 Second Vertical Ignition per 14 CFR 25.853(a), Appendix F, Part I, Paragraph (a)(1)(ii)				
Antero 840CN03, Vertical - ZX	0			0
Antero 840CN03, Flat - XY	0			0
	Test Mode	Average D <sub>s</sub> (maximum) within 4 minutes, (°D <sub>max</sub> )		
Smoke Density per BSS 7238, Rev C				
Antero 840CN03, Vertical - ZX	Flaming	0		
Antero 840CN03, Flat - XY	Flaming	0		
Smoke Density per AITM 2.0007B, Issue 3				
Antero 840CN03, Vertical - ZX	Flaming	0		
Antero 840CN03, Flat - XY	Flaming	0		
Antero 840CN03, Vertical - ZX	Non-Flaming	0		
Antero 840CN03, Flat - XY	Non-Flaming	0		



**Table 10: Antero 840CN03 Flame, Smoke and Toxicity Test Results - Fortus 450mc**

	Test Mode	CO ppm	SO <sub>2</sub> ppm	NO <sub>x</sub> ppm	HCN ppm	HCl ppm	HF ppm
<b>Toxic Gas Emission per BSS 7239, Rev. A</b>							
Antero 840CN03, Vertical - ZX	Flaming	5	0 (NI)	0 (NI)	0 (NI)	0 (NI)	0 (NI)
Antero 840CN03, Horizontal - XY	Flaming	<5	0 (NI)	0 (NI)	0 (NI)	0 (NI)	0 (NI)
<b>Toxic Gas Emission per AIM 3.0005, Issue 2</b>							
Antero 840CN03, Vertical - ZX	Flaming	5	0	0.1	0 (NI)	0 (NI)	0 (NI)
Antero 840CN03, Horizontal - XY	Flaming	3	0	0.3	0 (NI)	0 (NI)	0 (NI)
Antero 840CN03, Vertical - ZX	Non-Flaming	1	0	0	0 (NI)	0 (NI)	0 (NI)
Antero 840CN03, Horizontal - XY	Non-Flaming	1	0	0	0 (NI)	0 (NI)	0 (NI)
	Peak HRR (kW/m <sup>2</sup> )	Time to Peak Heat Release (seconds)		2 Minute Total HRR (kW-min/m <sup>2</sup> )			
<b>Heat Release Rate of Cabin Materials per 14 CFR 25.853(d), Appendix F, Part IV<sup>1</sup></b>							
Antero 840CN03, Vertical - ZX Antero 840CN03	57.7	300		0			
Antero 840CN03, Horizontal - XY	59.9	269		0.1			

<sup>1</sup> Sample thickness: 0.150 in.



## Flame, Smoke, and Toxicity (F900)

Antero 840CN03 was printed with a T20D tip on the Stratasys F900 and tested per 14 CFR 25.853, BSS 7238 and 7239, and AITM 2.0007B and 3.0005. The testing establishes that this material, samples 1.016 mm (0.040 in.) thick unless otherwise noted, **meets requirements** for:

- 60s and 12s Vertical Burn
- 15s Horizontal Burn
- Toxic Gas Emission
- Smoke Density
- Heat Release Rate of Cabin Materials

**Table 11: Antero 840CN03 Flame, Smoke, and Toxicity Test Results - F900**

	Avg Time to Extinguish (seconds)	Avg Burned Length (inches)	Avg Burned Length (centimeters)	Drip Time to Extinguish (seconds)
<b>12 Second Vertical Ignition per 14 CFR 25.853(a), Appendix F, Part I, Paragraph (a)(1)(ii)</b>				
Antero 840CN03, Vertical - ZX	3.2	0.3	0.76	0 (no drips)
Antero 840CN03, Horizontal - XZ	4.7	0.2	0.51	0 (no drips)
<b>60 Second Vertical Ignition per 14 CFR 25.853(a), Appendix F, Part I, Paragraph (a)(1)(i)</b>				
Antero 840CN03, Vertical - ZX	<1	0.5	1.27	0 (no drips)
Antero 840CN03, Horizontal - XZ	<1	0.5	1.27	0 (no drips)
	Avg Burn Rate			
	(in/min)		(cm/min)	
<b>15 Second Horizontal Ignition per 14 CFR 25.853(a), Appendix F, Part I, Paragraph (a)(1)(iv)(v)</b>				
Antero 840CN03, Vertical - ZX	0		0	
Antero 840CN03, Horizontal - XZ	0		0	
	Test Mode	Average $D_s$ (maximum) within 4 minutes, ( ${}^4D_{max}$ )		
<b>Smoke Density per BSS 7238, Rev. C</b>				
Antero 840CN03, Vertical - ZX	Flaming	0		
Antero 840CN03, Horizontal - XZ	Flaming	0		
<b>Smoke Density per AITM 2.0007B, Issue 3</b>				
Antero 840CN03, Vertical - ZX	Flaming	0		
Antero 840CN03, Horizontal - XZ	Flaming	0		
Antero 840CN03, Vertical - ZX	Non-Flaming	0		
Antero 840CN03, Horizontal - XZ	Non-Flaming	0		



**Table 12: Antero 840CN03 Flame, Smoke, and Toxicity Test Results - F900**

	Test Mode	CO ppm	SO <sub>2</sub> ppm	NO <sub>x</sub> ppm	HCN ppm	HCl ppm	HF ppm
<b>Toxic Gas Emission per BSS 7239, Rev. A</b>							
Antero 840CN03, Vertical - ZX	Flaming	5	0	0	0	0	0
Antero 840CN03, Horizontal - XZ	Flaming	<5	0	0	0	0	0
<b>Toxic Gas Emission per AITM 3.0005, Issue 2</b>							
Antero 840CN03, Vertical - ZX	Flaming	4	0	0.1	0	0	0
Antero 840CN03, Horizontal - XZ	Flaming	3	0	0.3	0	0	0
Antero 840CN03, Vertical - ZX	Non-Flaming	0	0	0	0	0	0
Antero 840CN03, Horizontal - XZ	Non-Flaming	1	0	0	0	0	0
	Peak HRR (kW/m <sup>2</sup> )	Time to Peak Heat Release (seconds)		2 Minute Total HRR (kW-min/m <sup>2</sup> )			
<b>Heat Release Rate of Cabin Materials per 14 CFR 25.853(d), Appendix F, Part IV<sup>1</sup></b>							
Antero 840CN03, Horizontal - XZ	55.9	286.7		0			
Antero 840CN03, Vertical - ZX	55.1	293		0.1			

<sup>1</sup> Sample thickness: 0.150 in.

## Outgassing

**Table 13: Antero 840CN03 Outgassing Test Results**

Sample	TML (%)	CVCM (%)	WVR (%)
Vertical Build - ZX	0.41	<0.01	0.17
Horizontal Build - XZ	0.45	0.01	0.15
<b>Testing Observations<sup>2</sup></b>			
Visible Condensate	Yes	Opaque	Yes
Percent Covered	10% (ZX), 25% (XZ)	Interference Fringes	No
Thin	Yes	Colored Fringes	No
Heavy	No	Sample Appearance After Test	No change
Transparent	No		

<sup>2</sup>For both XZ and ZX orientations.



# Appendix

**Figure 3: 2nd Heating Scan, DSC, for Antero 840CN03**

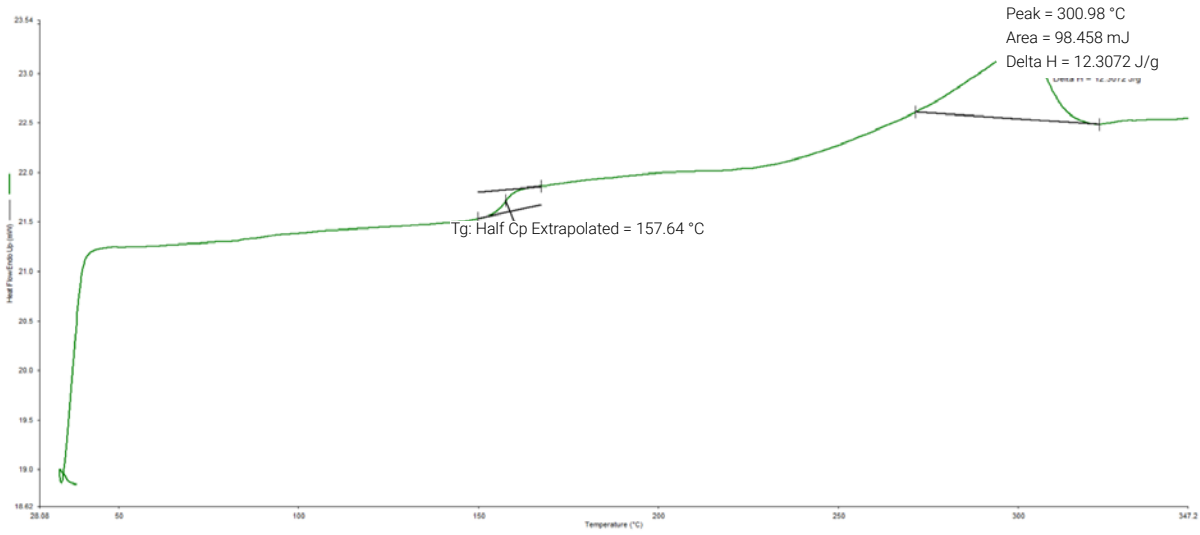

**Figure 4: TMA CTE Curve Normal to the Layers**

Sample: CTE Bar-Side-2  
Size: 6.3730 mm  
Method: Ramp  
Comment: RT-300C @ 3C/min

## TMA

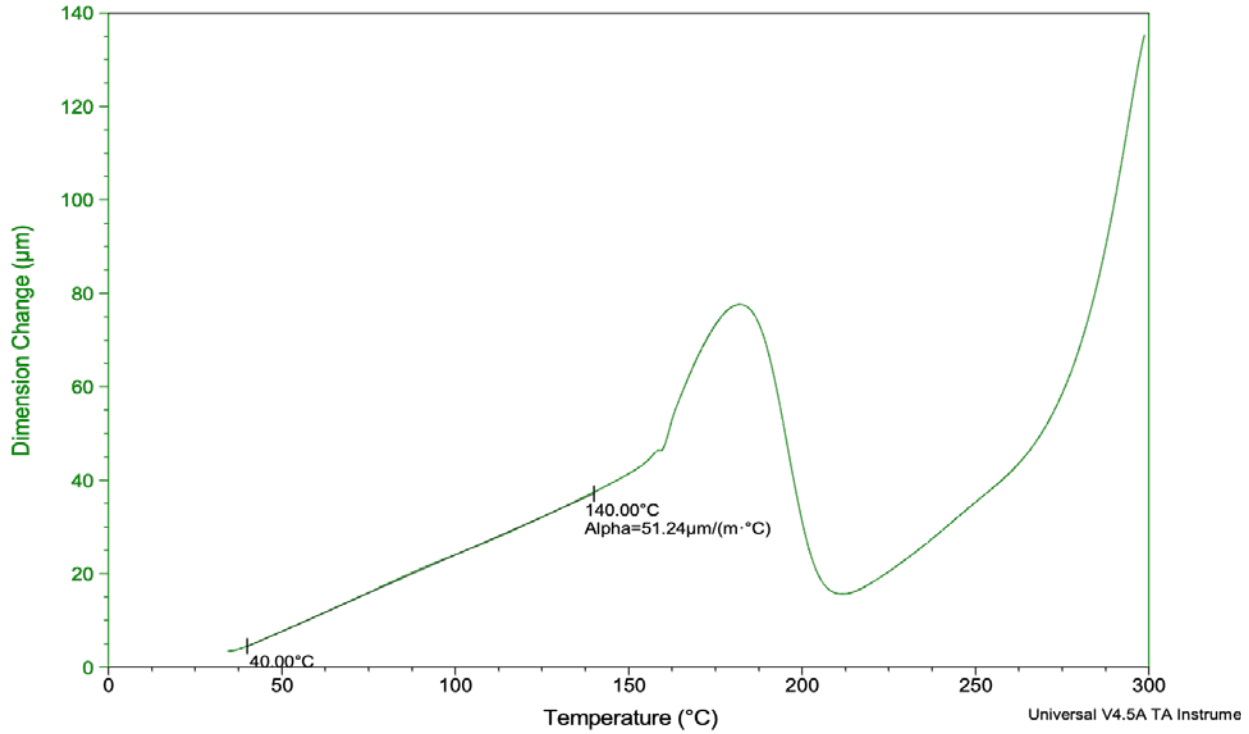
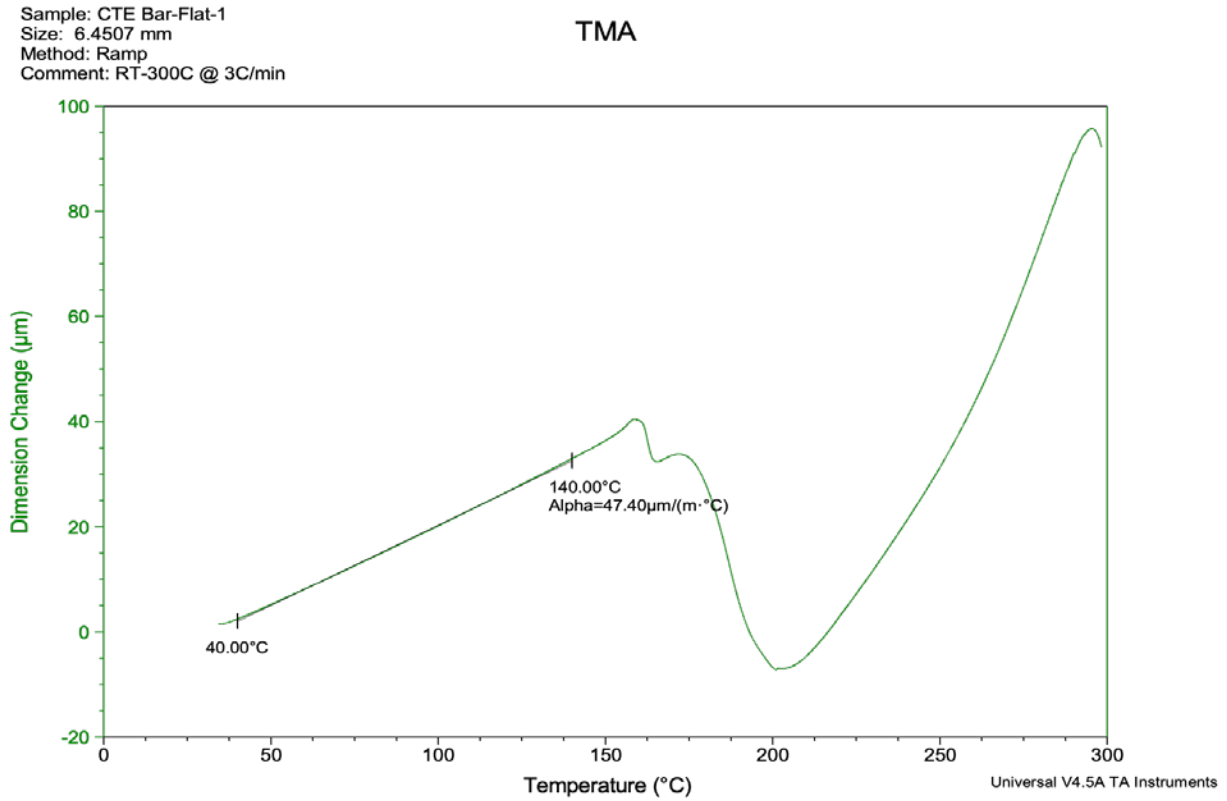



Figure 5: TMA CTE Curve Inplane with the Layers



alphacam GmbH  
 Erlenwiesen 16  
 D-73614 Schorndorf  
 Tel.: +49 7181 9222-0  
 info@alphacam.de

alphacam austria GmbH  
 Handelskai 92, Gate1 / 2. OG / Top A  
 A-1200 Wien  
 Tel.: +43 1 3619 600-0  
 info@alphacam.at

alphacam swiss GmbH  
 Zürcherstrasse 14  
 CH-8400 Winterthur  
 Tel.: +41 52 26207-50  
 info@alphacam.ch



**stratasys.com**  
 ISO 9001:2015  
 Certified



**MATERIAL DATA SHEET**  
**FDM**

© 2024 Stratasys. All rights reserved. Stratasys, the Stratasys Signet logo, FDM, Fortus, Antero, and F900 are registered trademarks of Stratasys Inc., Fortus 450mc, and SUP8000B are trademarks of Stratasys, Inc. All other trademarks are the property of their respective owners, and Stratasys assumes no responsibility with regard to the selection, performance, or use of these non-Stratasys products. Product specifications subject to change without notice. MDS\_FDM\_Antero840CN03\_0824a